

**Caution:**

Do not burn sulfur or other sulfur-containing materials near the fixture.

Avoid exposing the LED fixture to corrosive gases (VOCs) or reactive substances, such as sulfide or sulfur-based sprays, vaporizers or misters, chlorine-based cleaners applied directly to the fixture, or other halogen compounds.

If chlorine-based agents are used for general room cleaning, ensure the fixture is powered off, not directly exposed, and that the room is well ventilated before turning the fixture back on.



# TARANTULA BORG EVOLUTION ULTRA

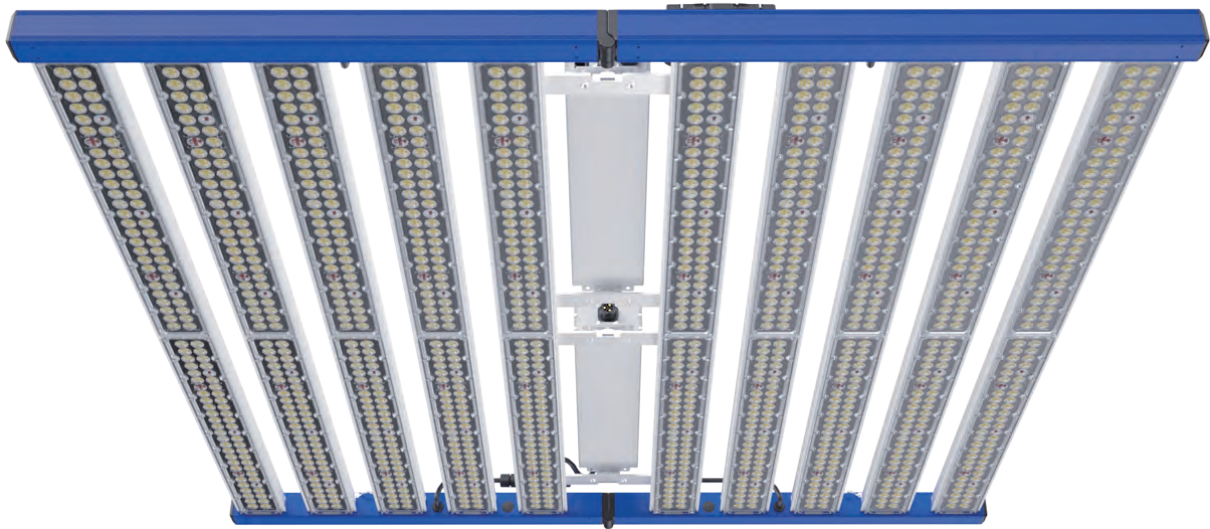

Grand Master Leds  
[www.grandmasterleds.com](http://www.grandmasterleds.com)

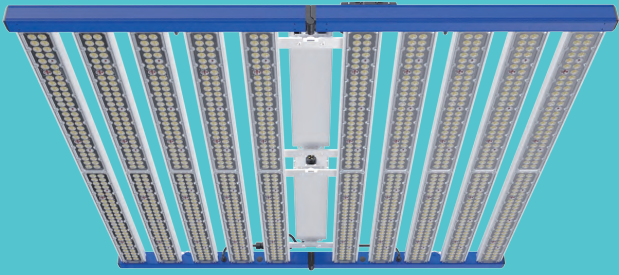

# TARANTULA BORG EVOLUTION ULTRA

HIGH EFFICIENCY

POWER SAVING

ADJUSTABLE SPECTRUM

## TARANTULA BORG EVOLUTION ULTRA

- Manual Knob Dimming + RJ Port Dimming
- Folding Design for Fast and Easy Installation
- Adjustable Spectrum
- 5-Year Warranty
- IP 66 Waterproof
- Input Voltage: 120-277Vac

### Specifications

Model Name	TARANTULA BORG EVOLUTION ULTRA		
Input Voltage	120 Vac	240 Vac	277 Vac
Typical Input Current	13.5 Amps	6.9 Amps	6 Amps
Power Factor	0.99	0.95	0.95
Wattage +/- 5%	1600W 714W+714W+102W+70W	1570W 700W+700W+100W+70W	1570W 700W+700W+100W+70W
Qty. of Light Bars	10 Bars	10 Bars	10 Bars

LED Driver	Fahold	Surge Protection	6KV
LED Brand	LEDESTAR	LED Configuration	18000K + 485nm & 2200K & 640nm + 660nm
Manual Knob Dimming	40%   50%   60%   80%   100% OFF	LED life time	>100,000 hours
RJ Port Dimming	10%~100% DIM-TO-OFF	Power Cord Length	10' (3.05M)
IP Rate	IP 66	Max. Ambient Temp.	104 °F (40 °C)
Warranty	5-year	Mounting Height	>36" (Above Canopy)

Packaging (Luminaire)		Packaging (Driver)	
Carton Size	124 x 67 x 16cm (48.82" x 26.38" x 6.3")	Carton Size	56 x 45 x 14cm (22.05" x 17.72" x 5.51")
Weight	20.9 kg (46.08 lbs)	Weight	8.5kg (18.74 lbs)
Qty. / Ctn.	1PC	Qty. / Ctn.	1 Set

## Details

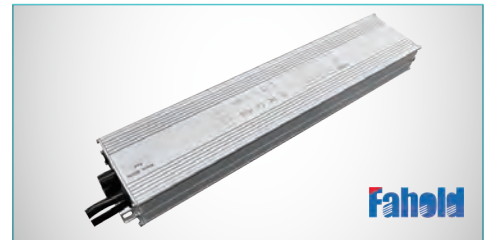
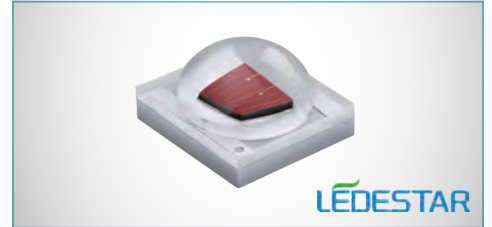
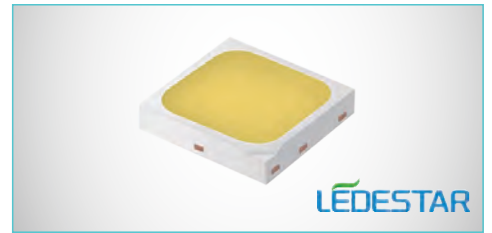

## Plug

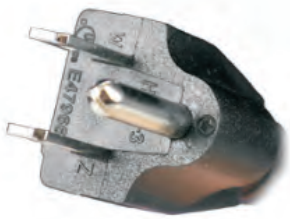

USA 120Vac (NEMA 5-15P)  
Standard



USA 240Vac (NEMA 6-15P)  
Optional



USA 277Vac (NEMA 7-15P)  
Optional

## Dimensions & Weight

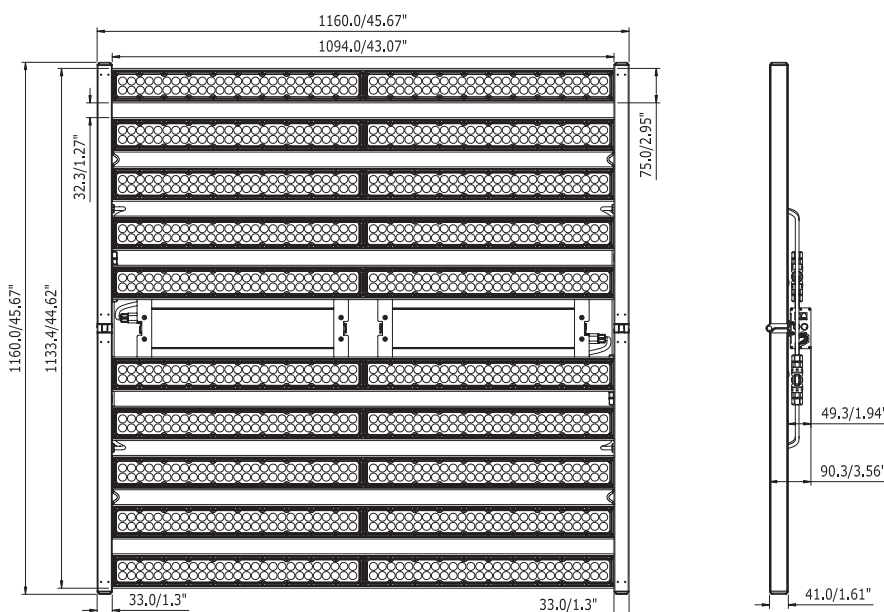

Fixture Dimensions:  
1160mm x 1160mm x 90.3mm  
(45.67" x 45.67" x 3.56")

Fixture Net Weight:  
25.13 kg (55.4lbs)

# RJ Port Dimming 10%~100% DIM-T0-OFF

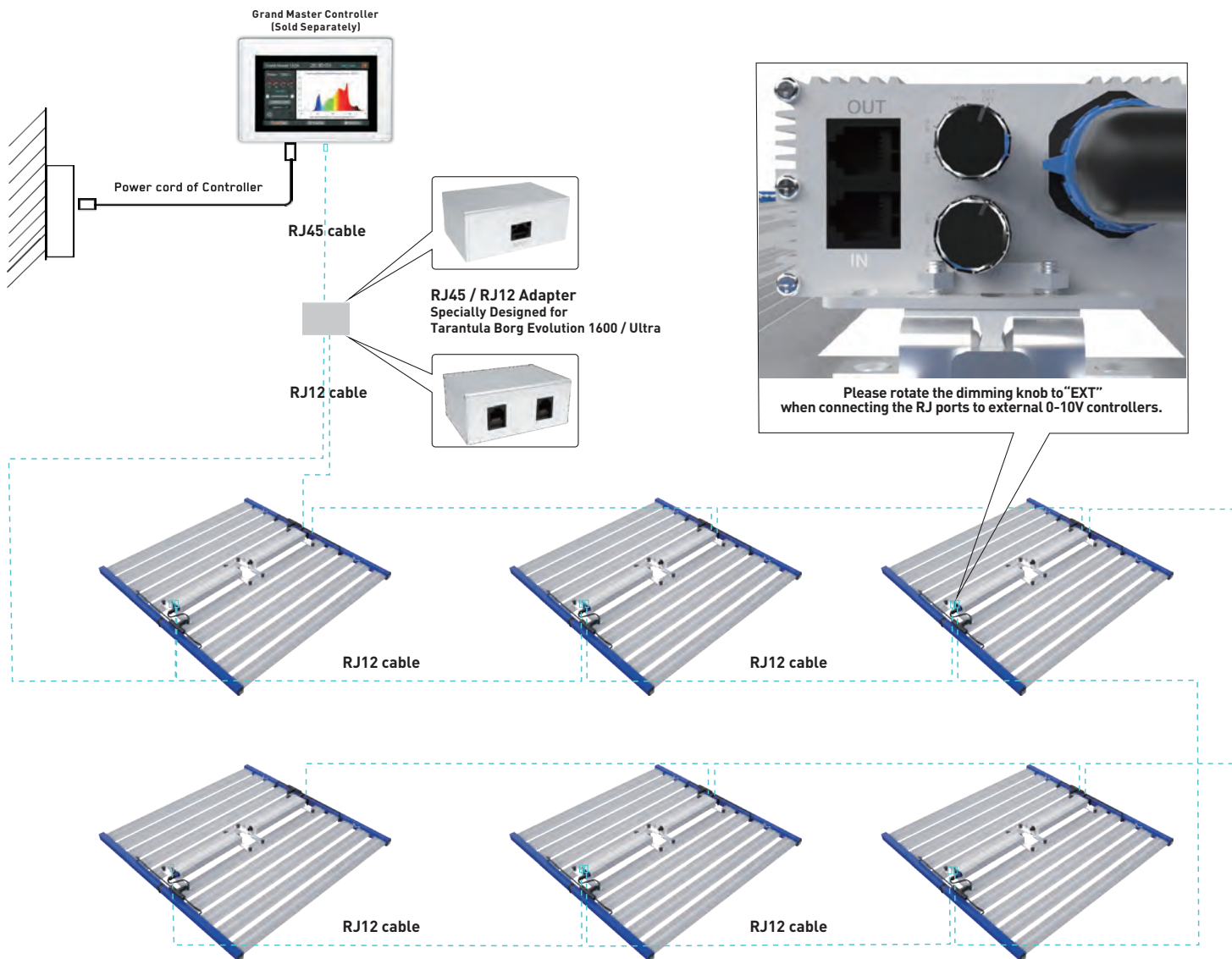

## Control Signal Input and Output

RJ45 / RJ12 Adapter Output Side (RJ12)					
PIN 1	PIN 2	PIN 3	PIN 4	PIN 5	PIN 6
Dim 2	Dim 1	GND	GND	Dim 1	Dim 2
LED Driver Input Side (RJ12)					
PIN 1	PIN 2	PIN 3	PIN 4	PIN 5	PIN 6
Dim 2	Dim 1	GND	GND	Dim 1	Dim 2
LED Driver Output Side (RJ12)					
PIN 1	PIN 2	PIN 3	PIN 4	PIN 5	PIN 6
Dim 2	Dim 1	GND	GND	Dim 1	Dim 2

# Spectrum Possibilities (SPD)

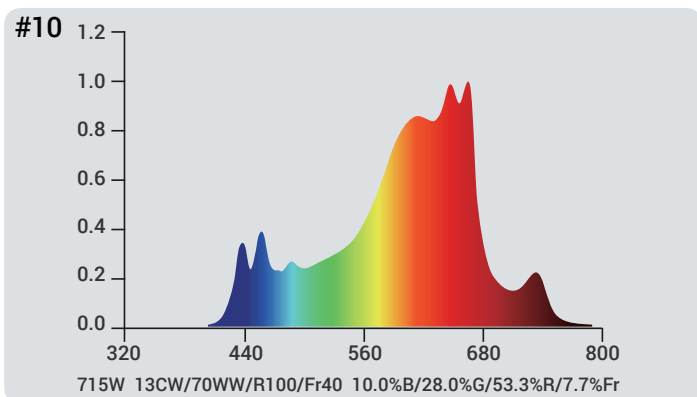
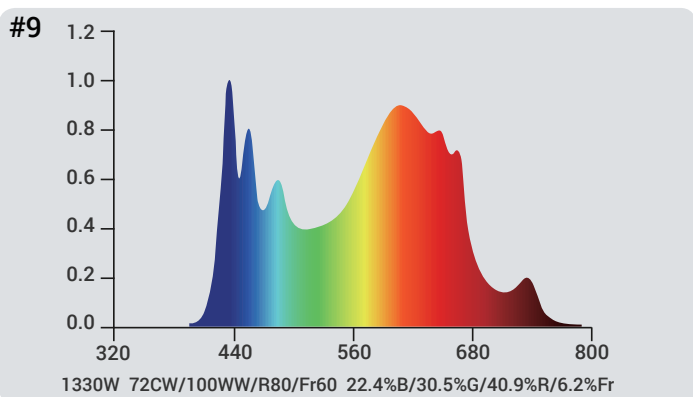
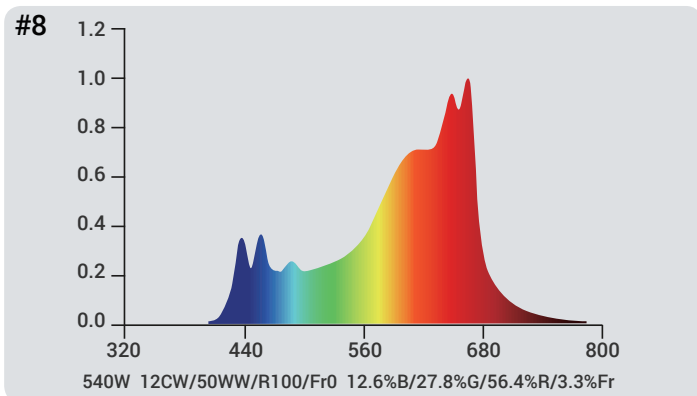
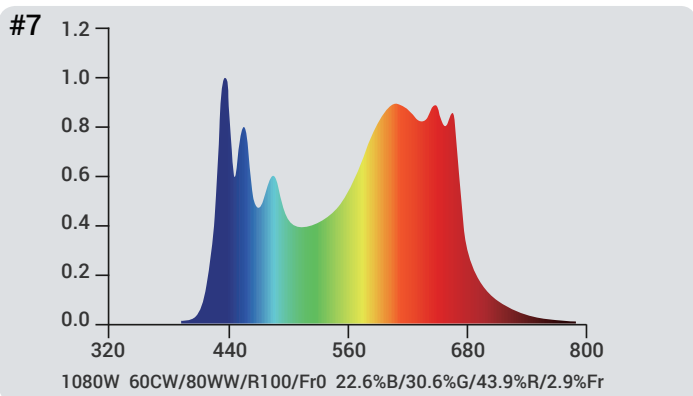
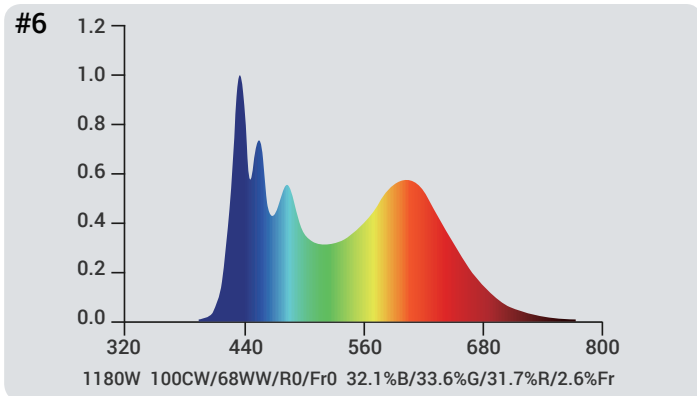
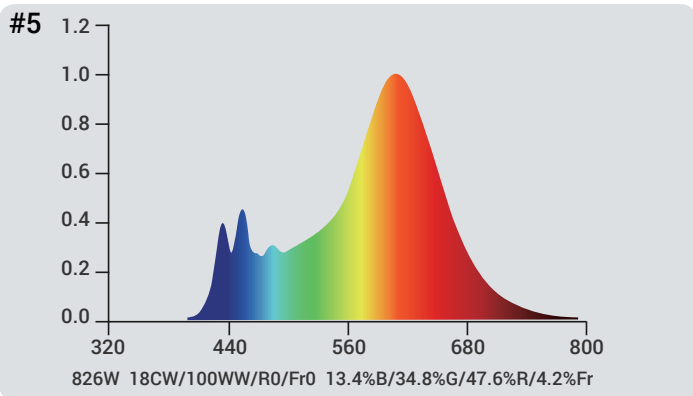
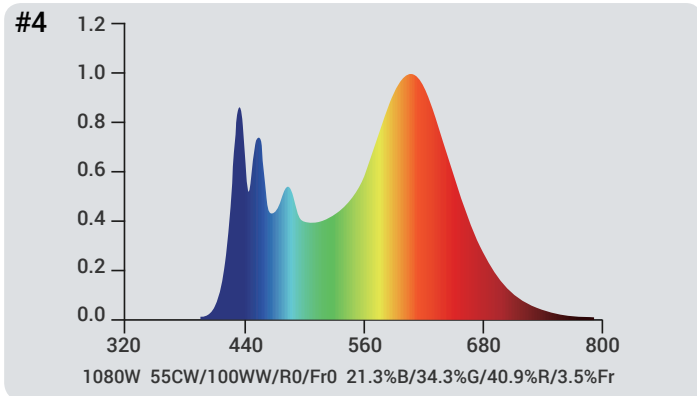
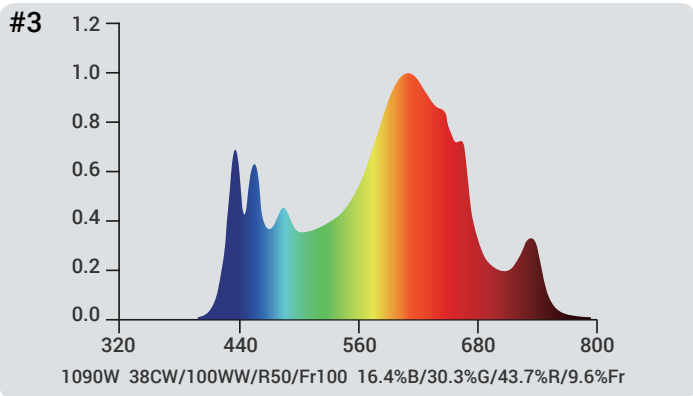
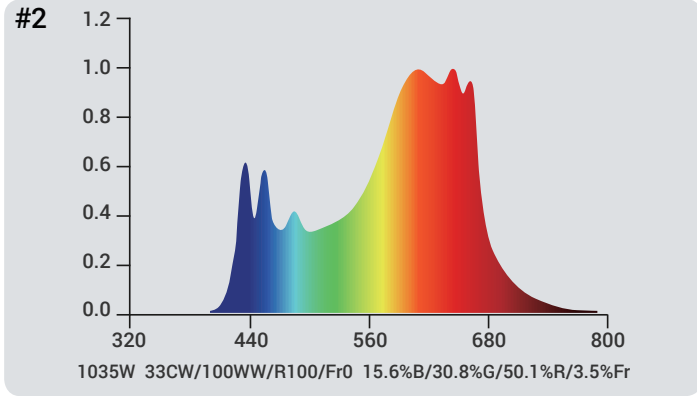
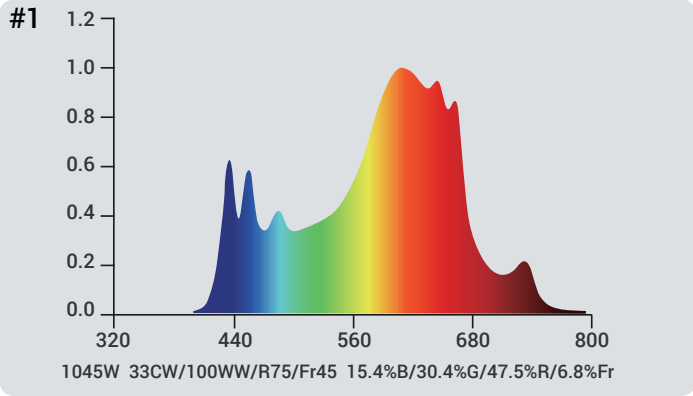

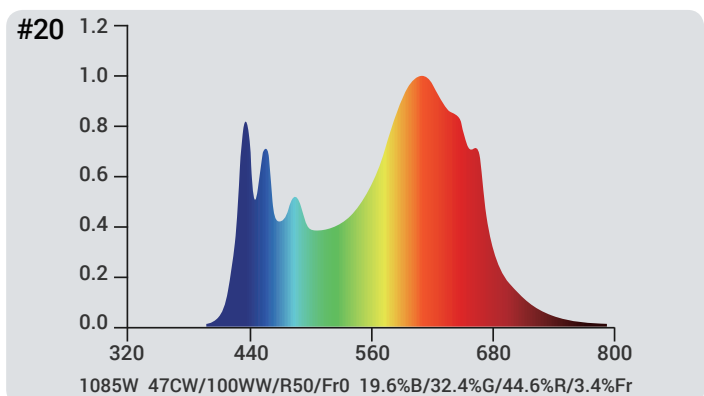
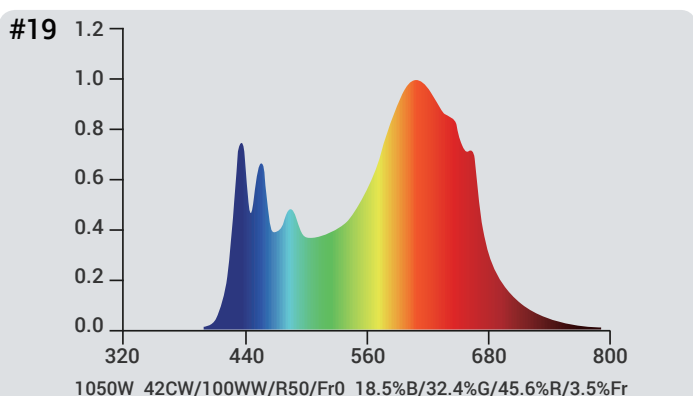
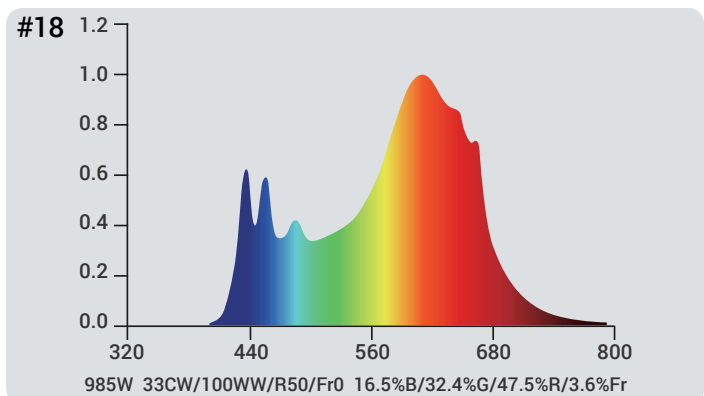
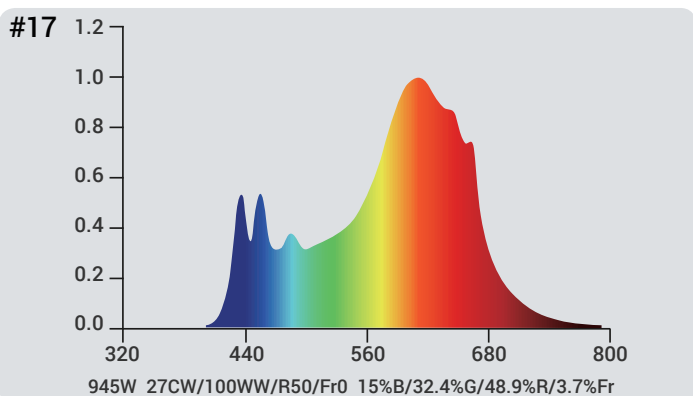
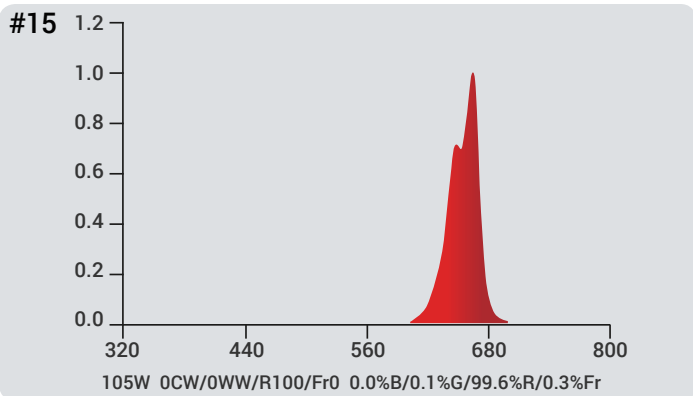
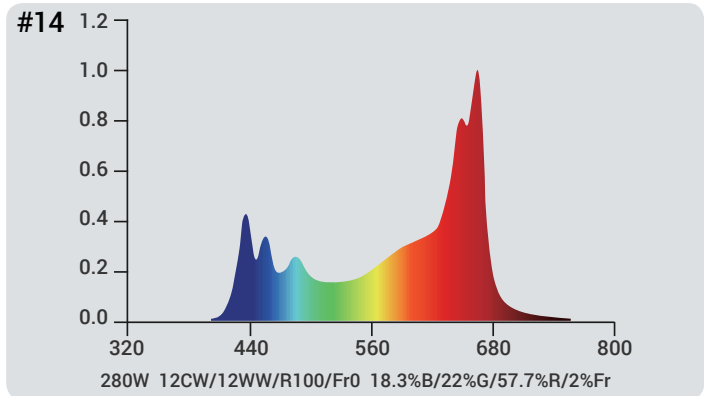
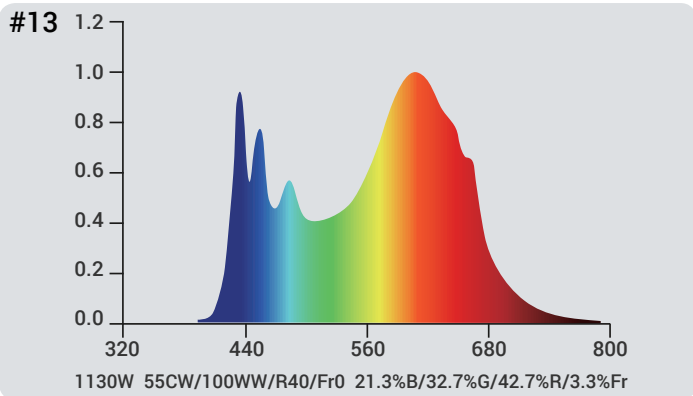
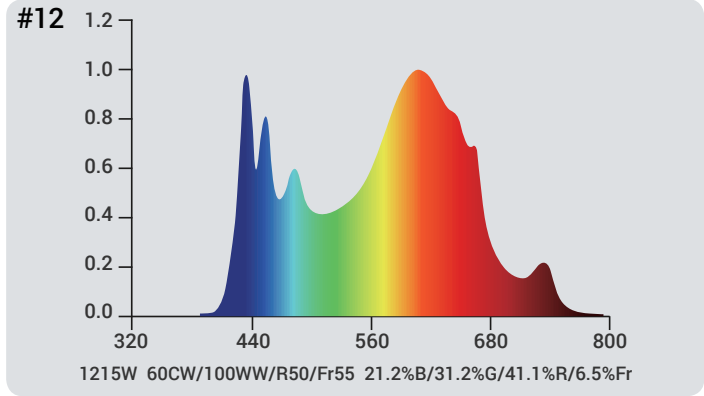
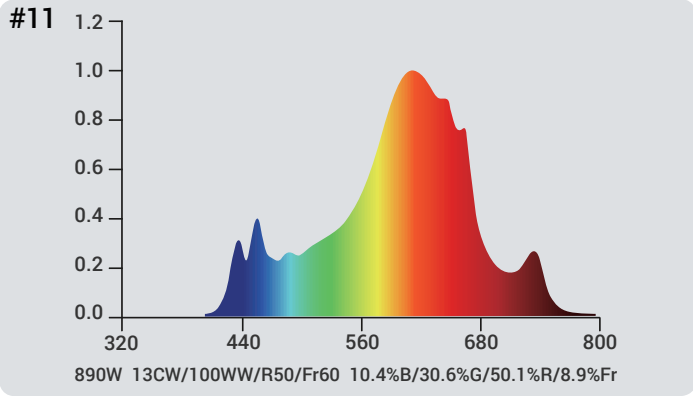

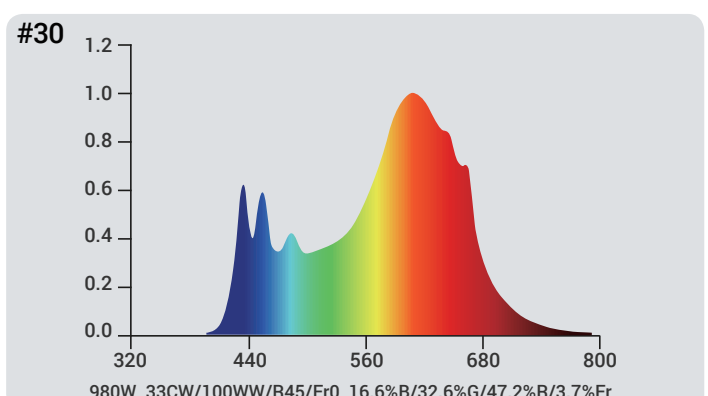
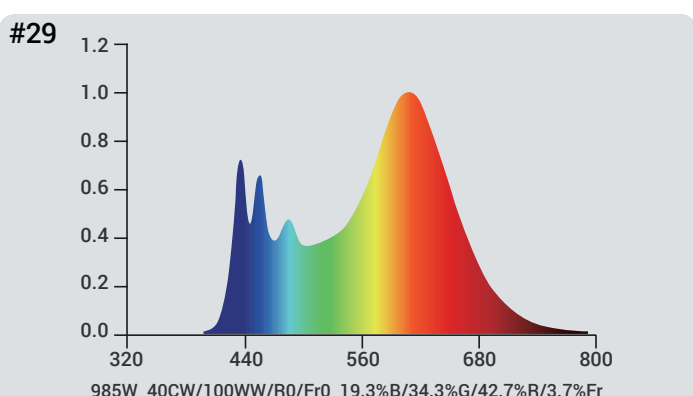
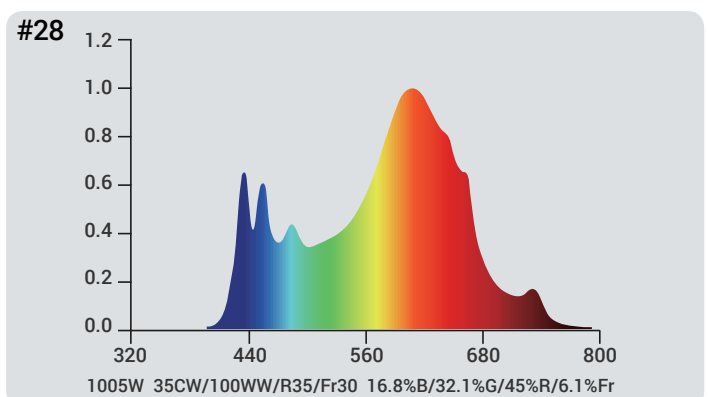
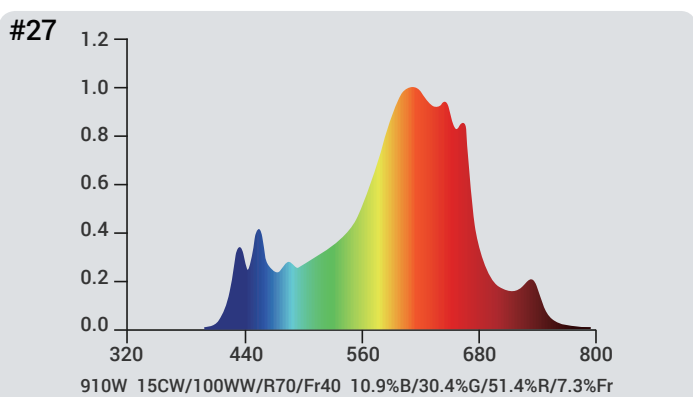
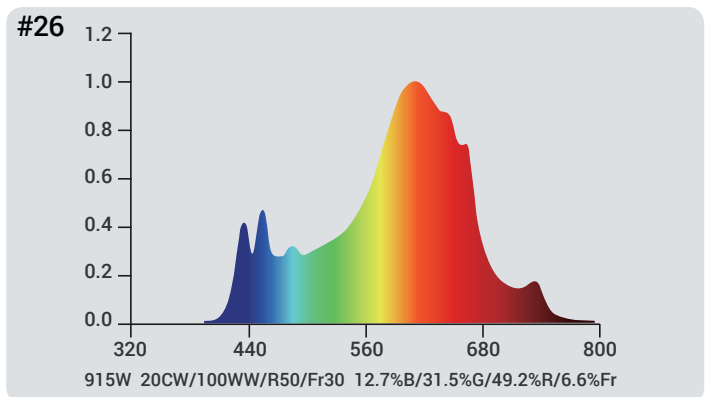
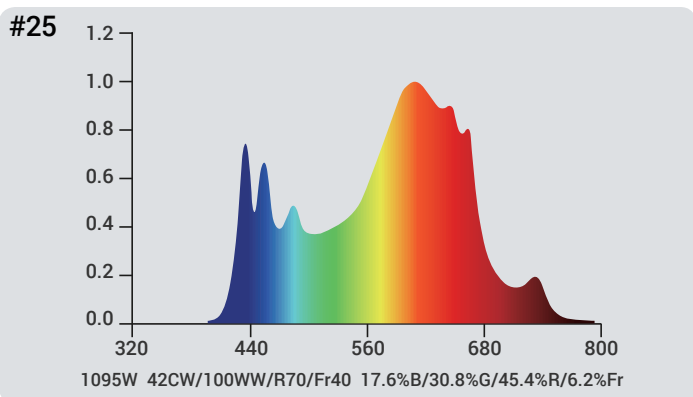
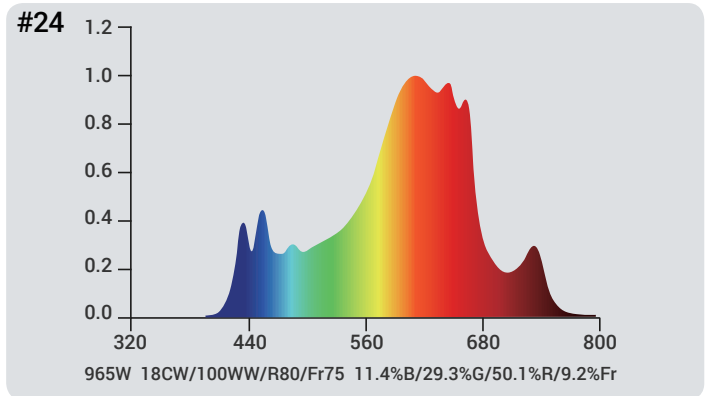
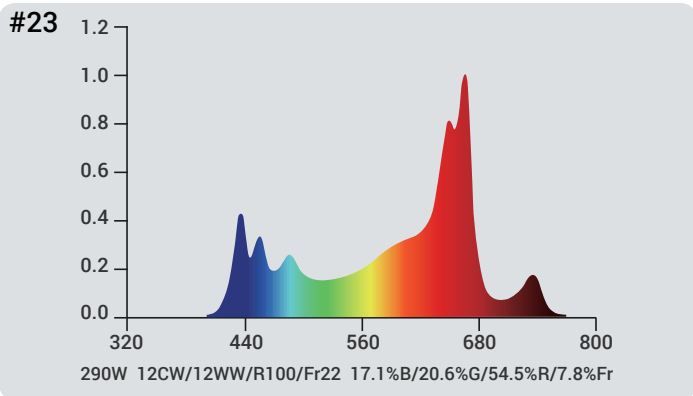
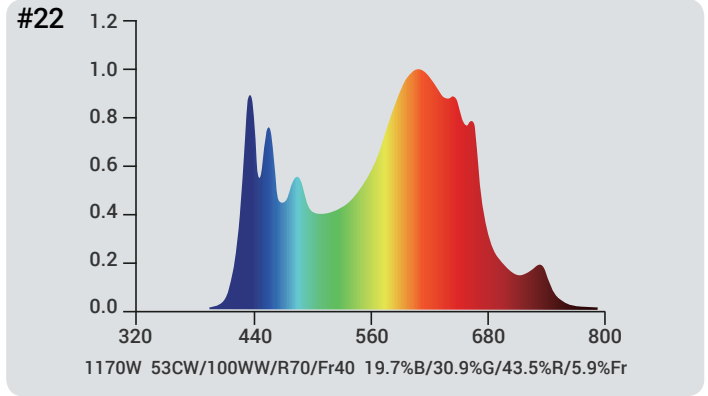
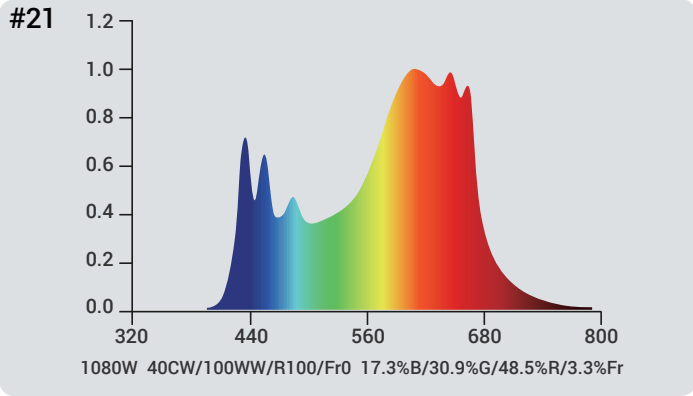

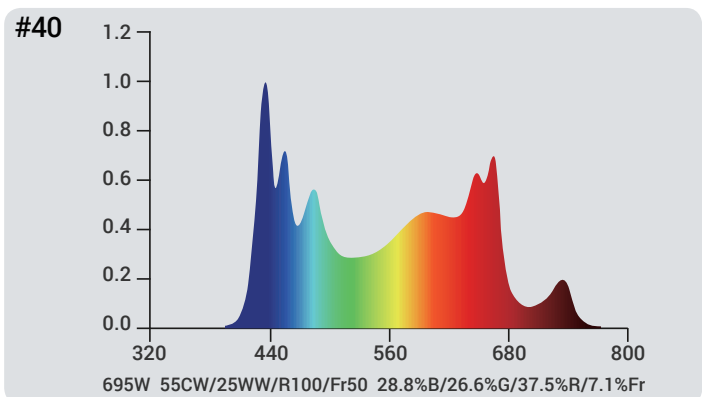
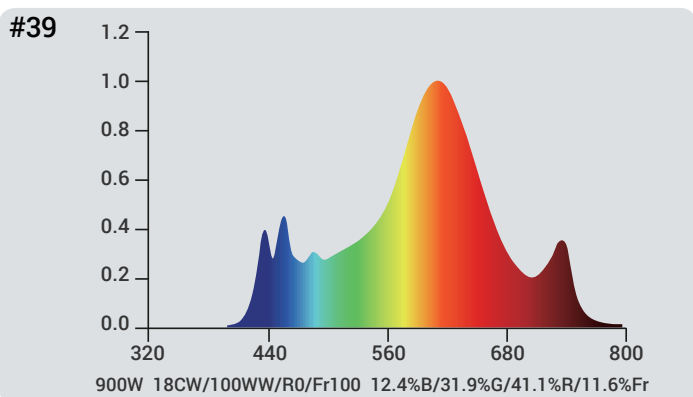
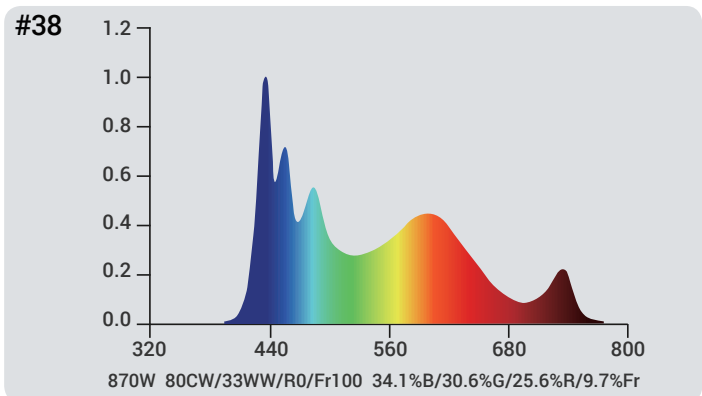
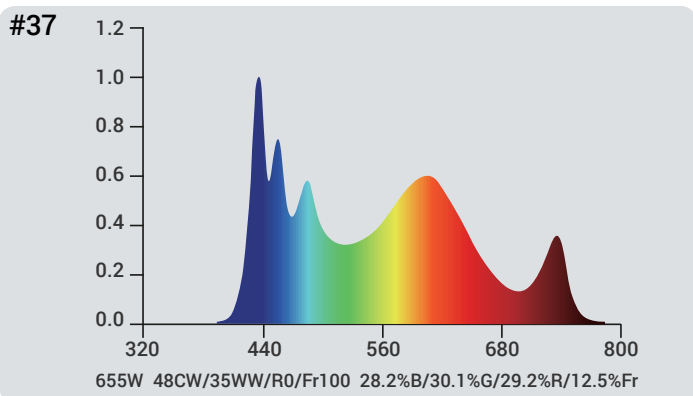
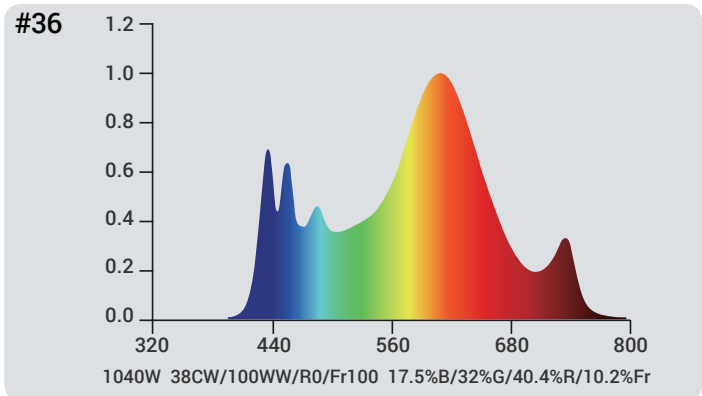
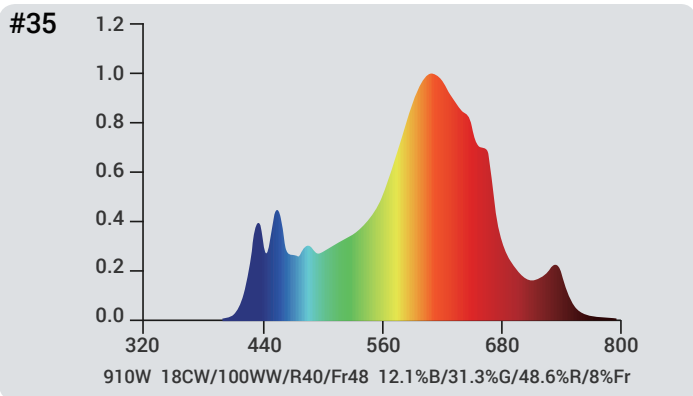
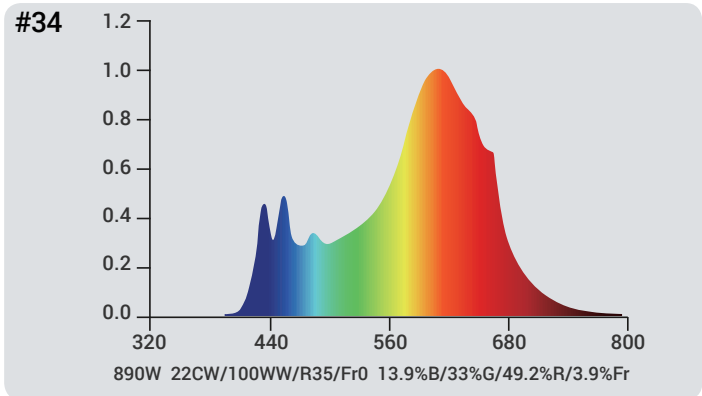
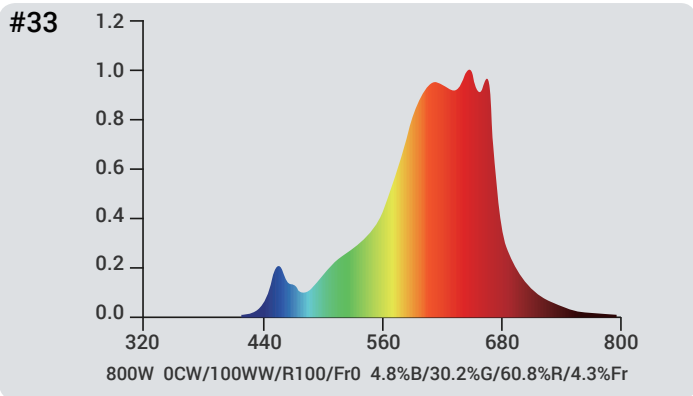
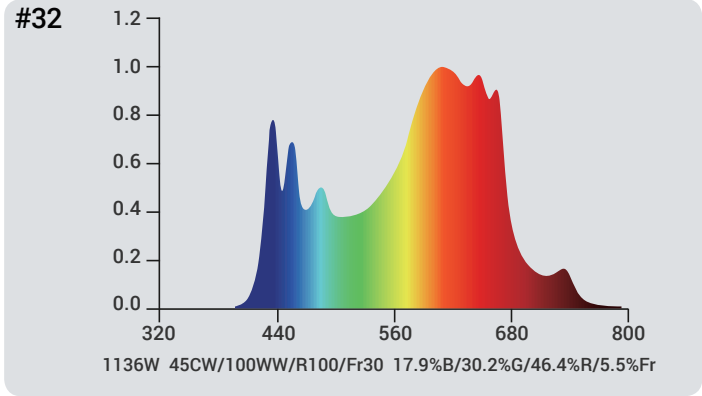
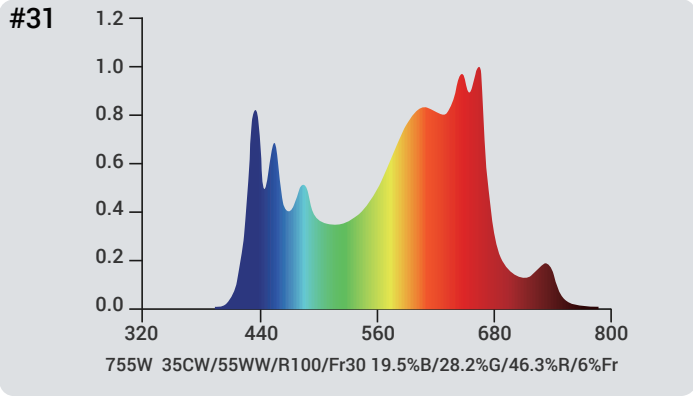

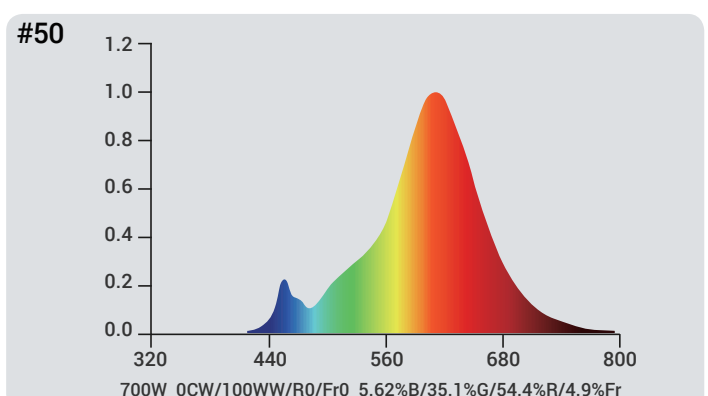
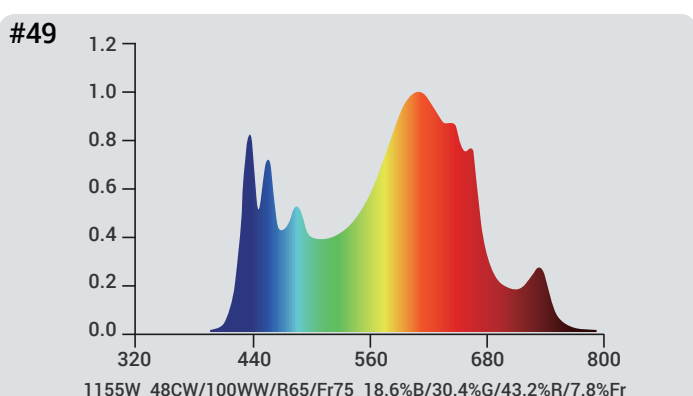
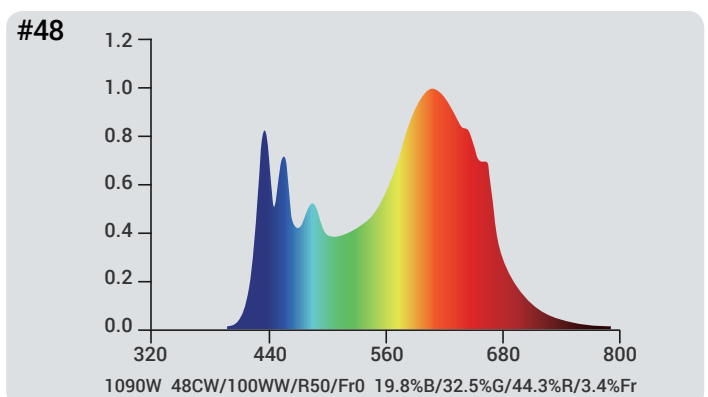
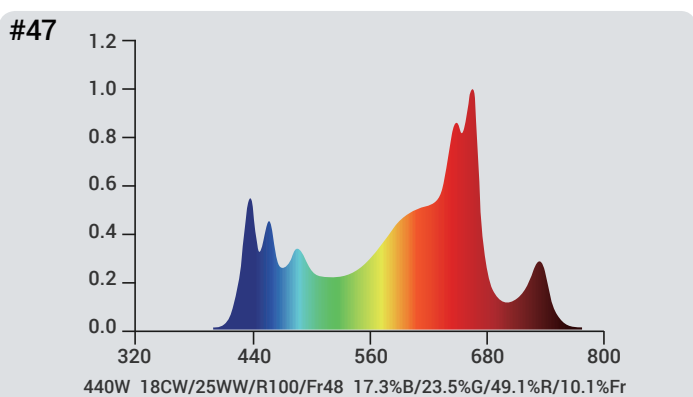
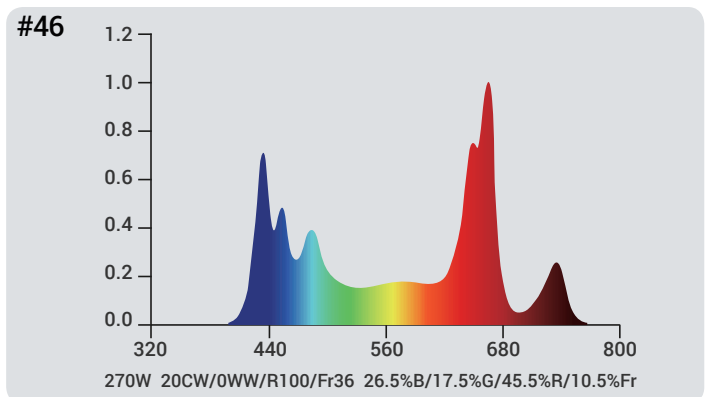
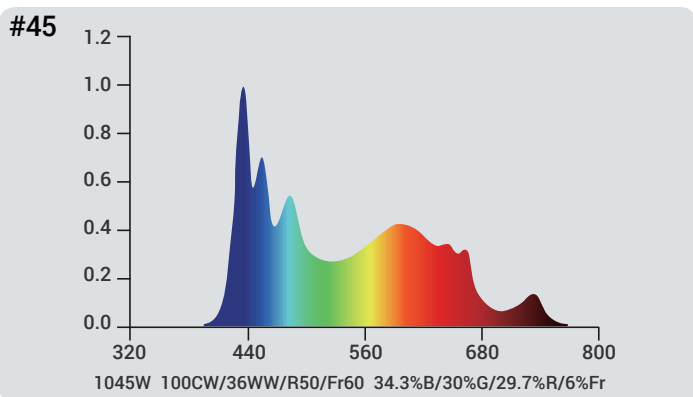
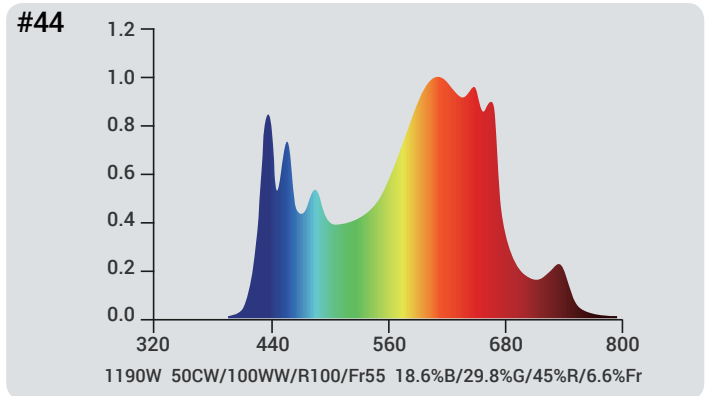
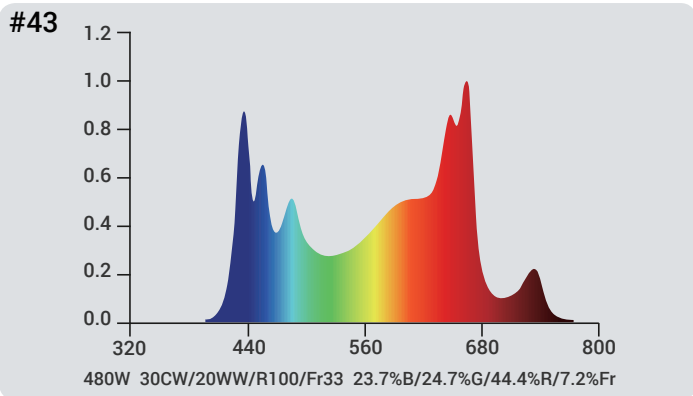
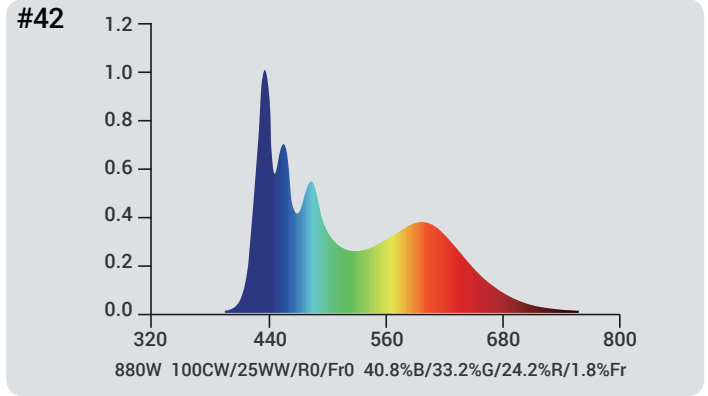
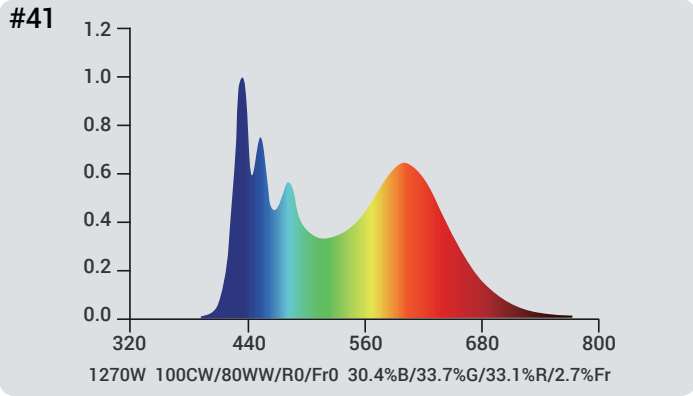

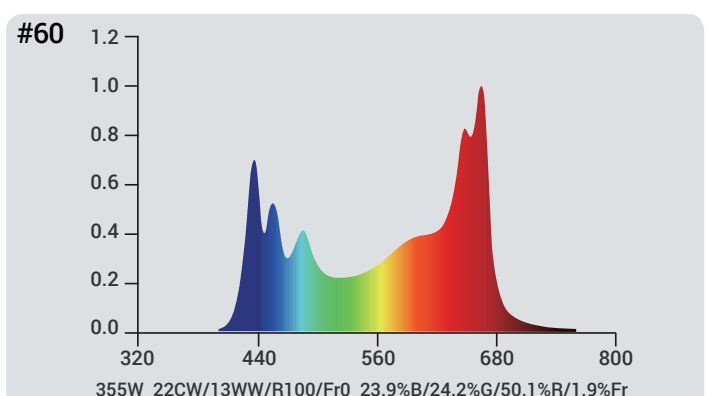
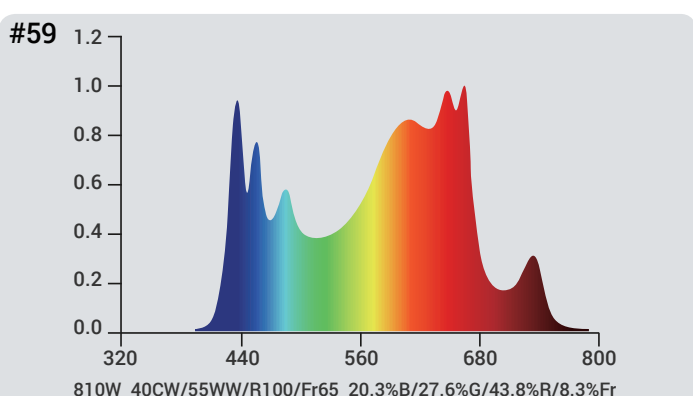
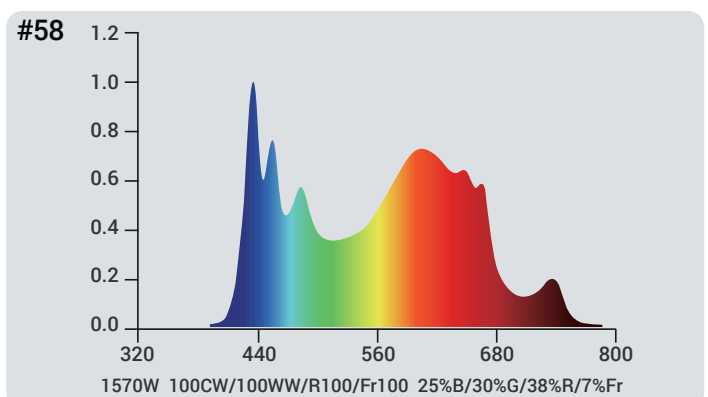
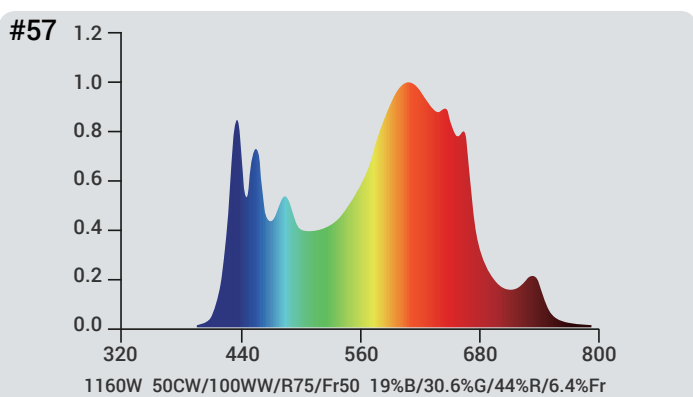
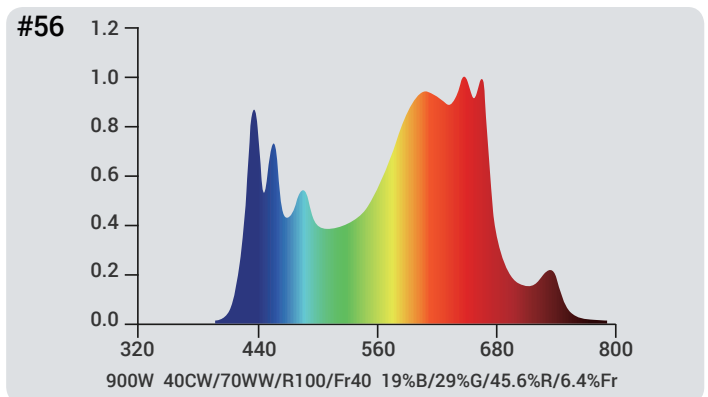
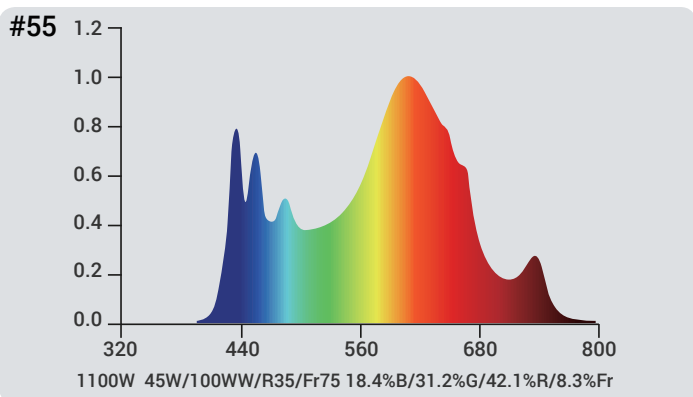
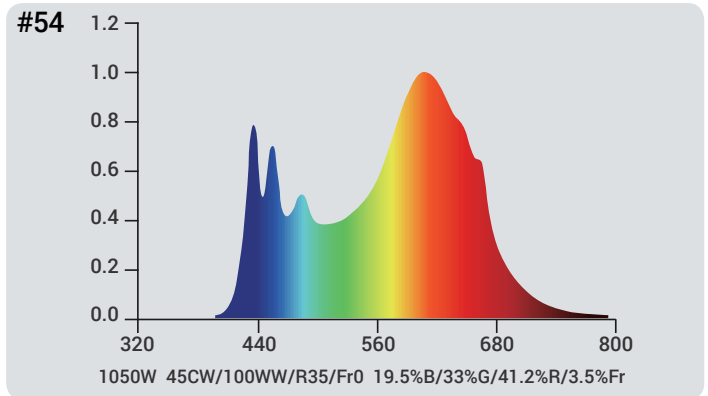
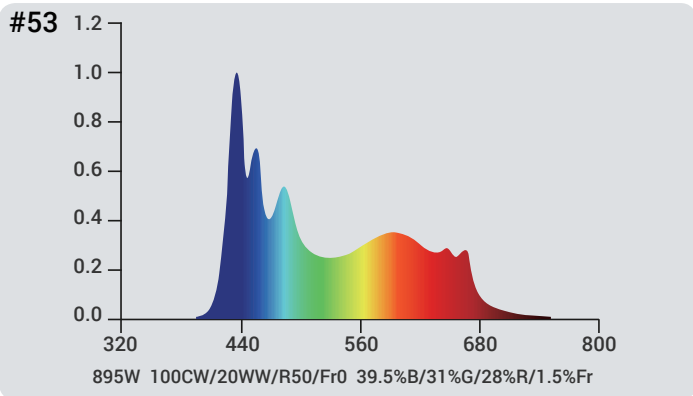
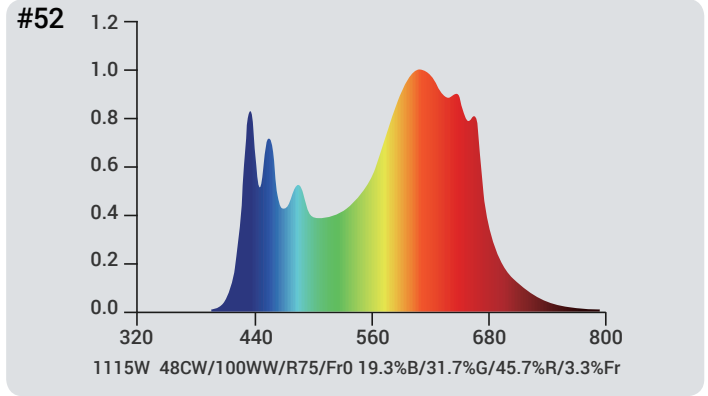
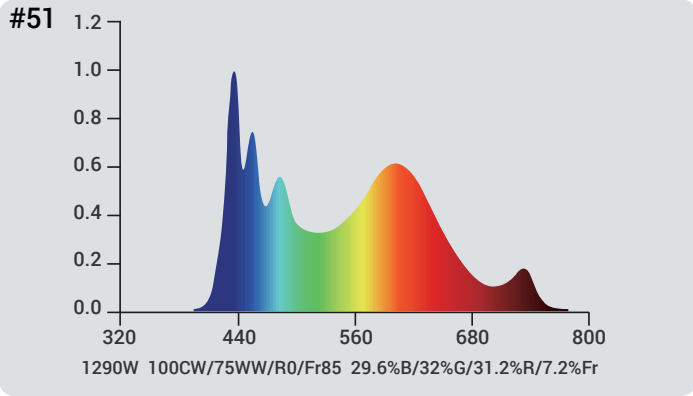

## Safety Warnings and Recommendations

---

**Warning!** Carefully read the warnings below before using or working with the product!

Always adhere to the local rules and regulations when installing or using the LED fixture.

Do not open or disassemble the LED fixture, it contains no serviceable parts inside. Opening or modifying the LED fixture can be dangerous and will void the warranty.

Wearing protective gloves and glasses is recommended during installation.

Do not use the LED fixture when either the LED fixture has been dropped or is damaged or its power cord is damaged.

Replace the power cord only with original certified cords. Keep the power cord away from hot surfaces.

Modifications to the cords can lead to unwanted electromagnetic effects, which makes the product not comply with legal requirements.

Do not plug the LED fixture into a supply voltage other than what is instructed on the fixture.

Always disconnect the LED fixture from mains before performing any maintenance.

The LED lighting product is extremely bright. Do not stare directly into any of the lights.

The LED fixture will get hot during operation. Do not touch when the light is on. Keep the LED fixture away from children.

Always allow for a cool down period of at least 30 min. before touching the LED rails. Touching the LED rails when the fixture is lit or immediately afterwards can result in severe burns!

Do not expose the LED fixture to:  
(ambient) temperatures outside the specified range;  
dust and contamination;  
direct sunlight during use or HID light that could heat up the ballast.

Do not use the LED fixture near flammable, explosive or reactive substances.

**The installation and use of the LED fixture are the responsibility of the end user. Incorrect use or installation can lead to failure and damage to the LED fixture. Damage to the LED fixture and electronic circuitry because of incorrect installation and use will void the warranty.**

# Installation Instructions

1

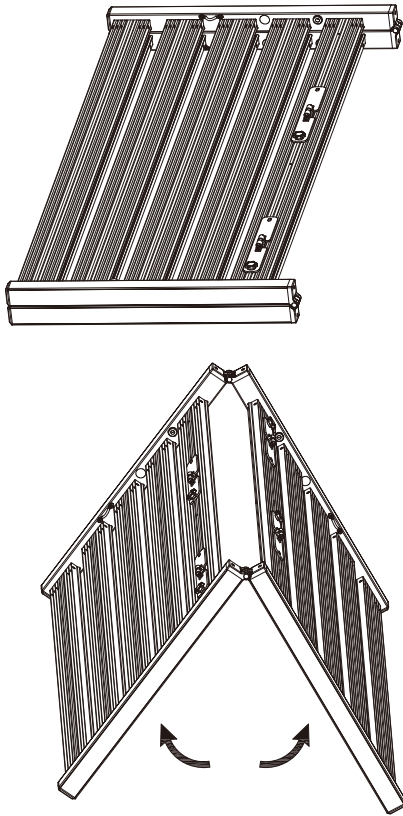

Unfold the LED fixture.

2

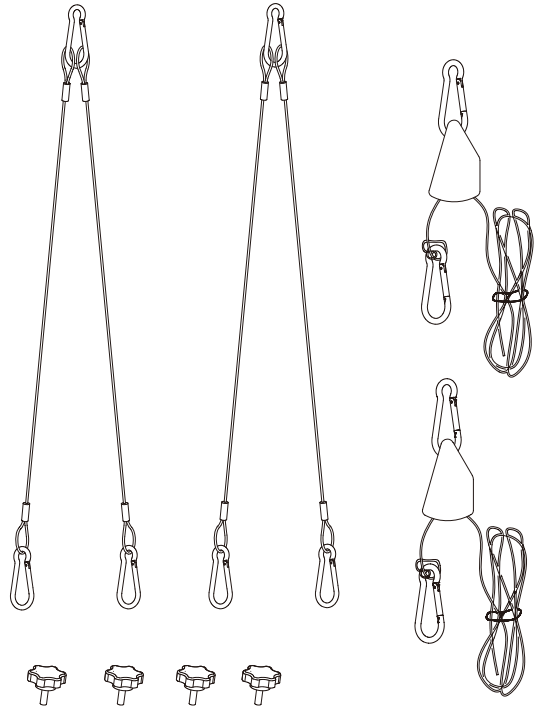

Take out the accessories from their bags.

3

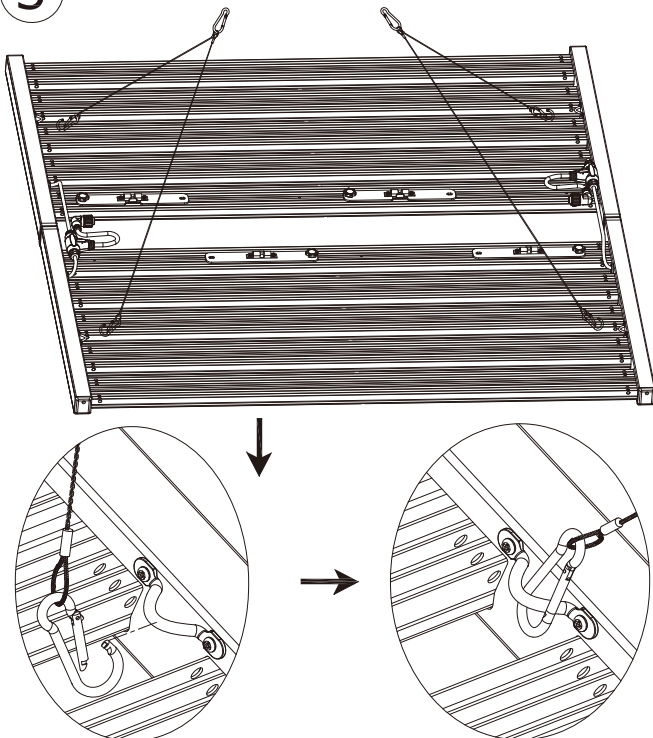

Connect carabiner hooks with mounting rings (on fixture frame).

4

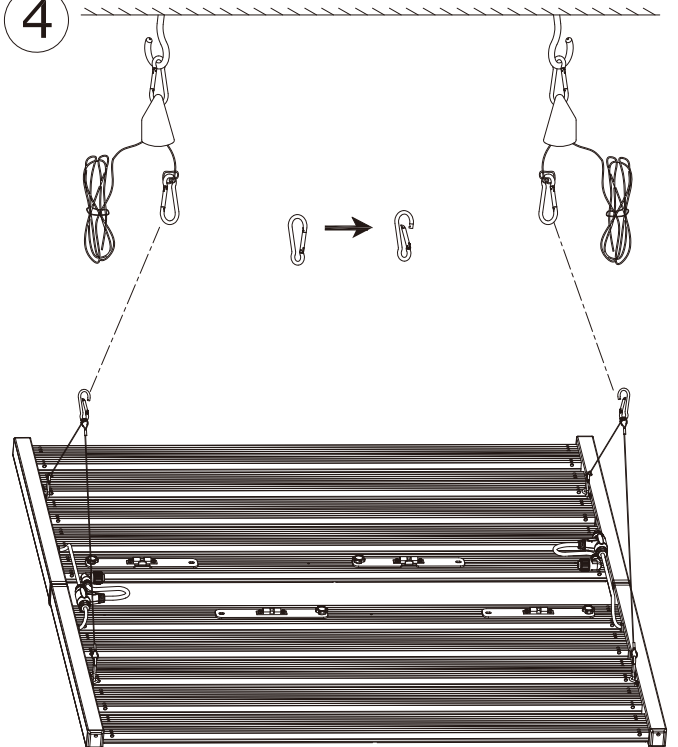

Attach steel ropes to adjustable ratchet hangers.

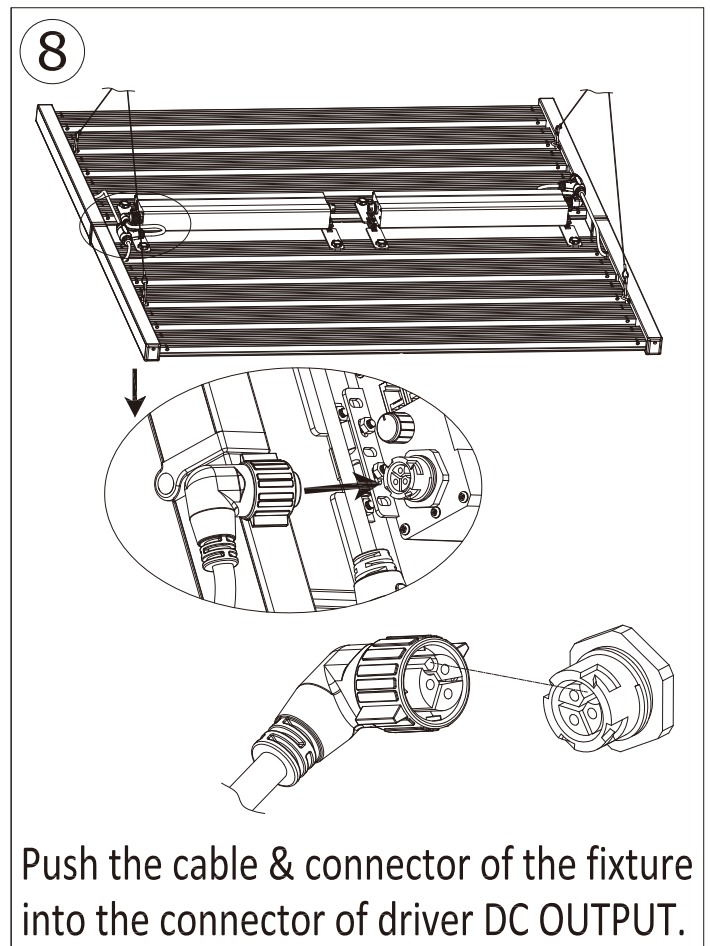
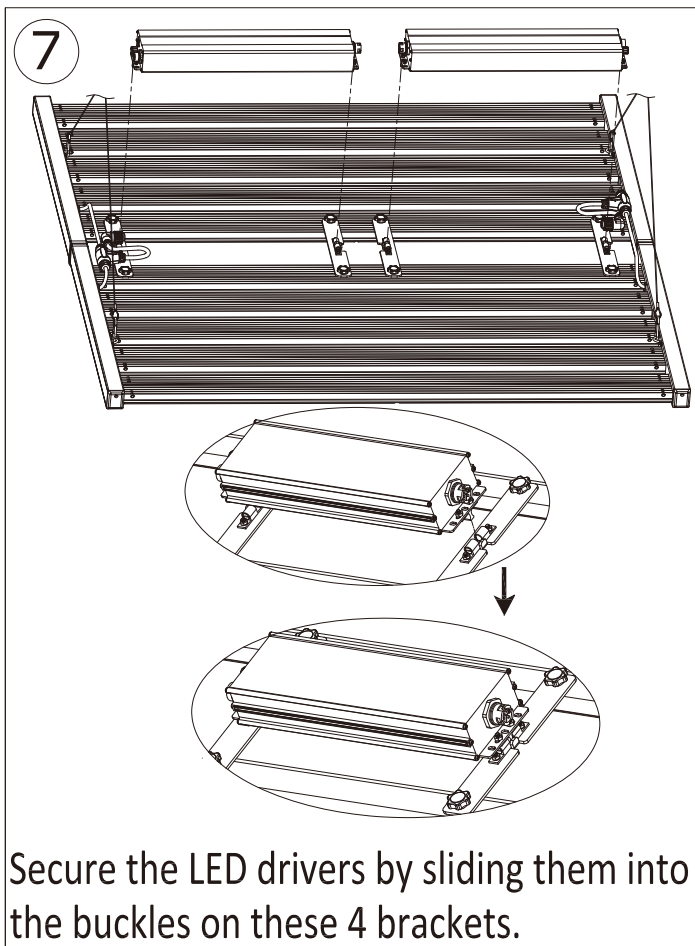
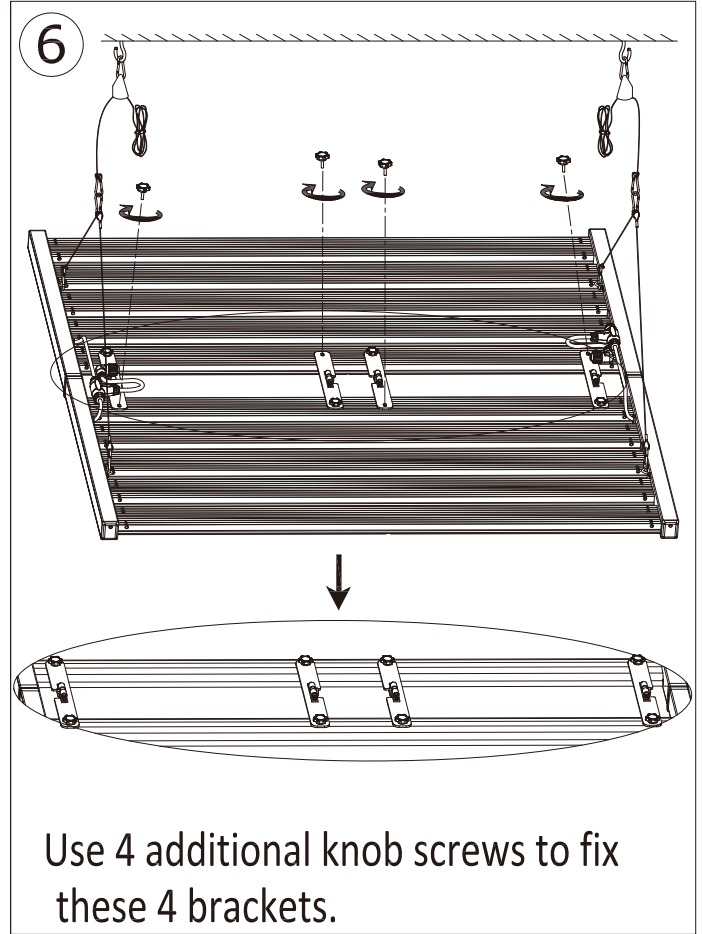
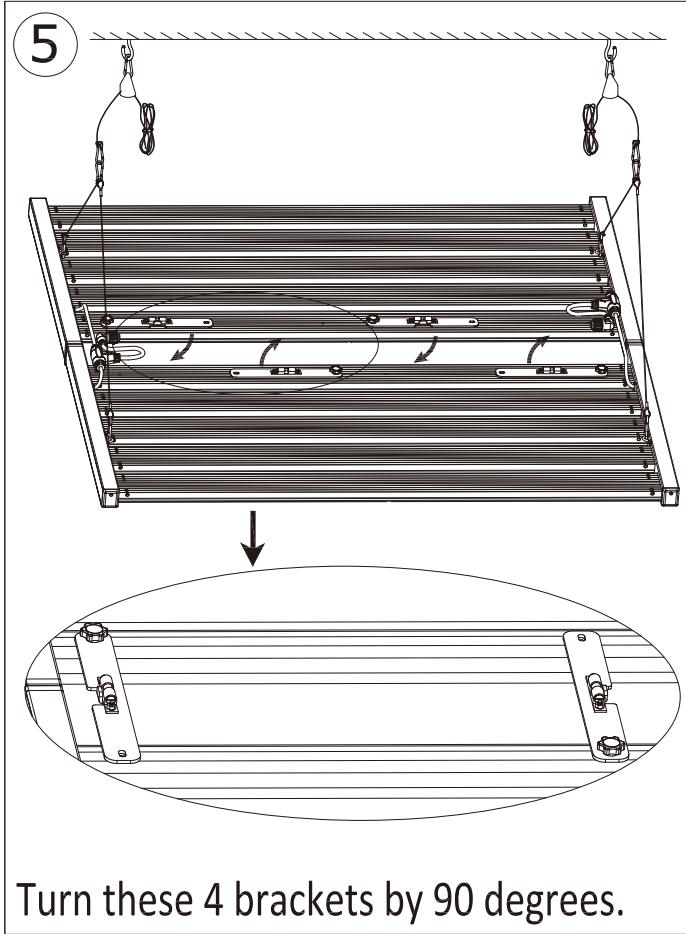

9

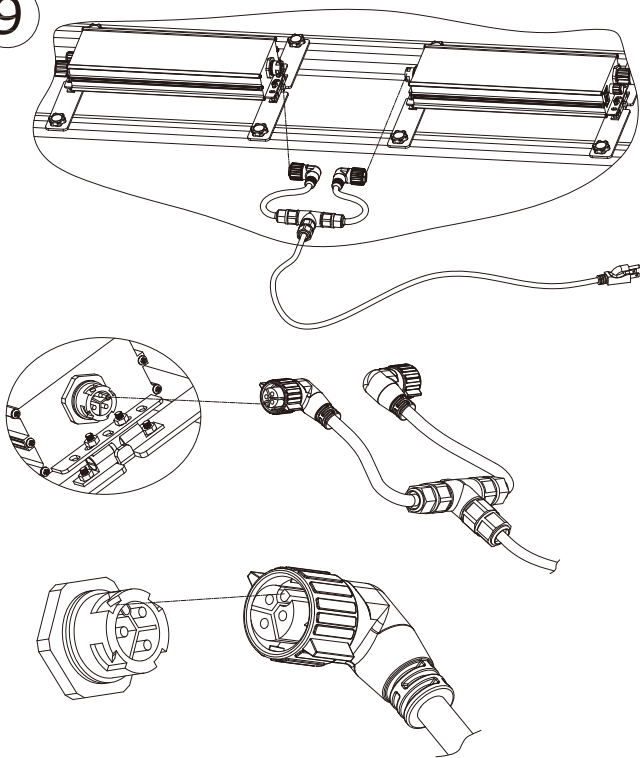

Push the connector of the AC power cord into the connector of driver AC INPUT.

10

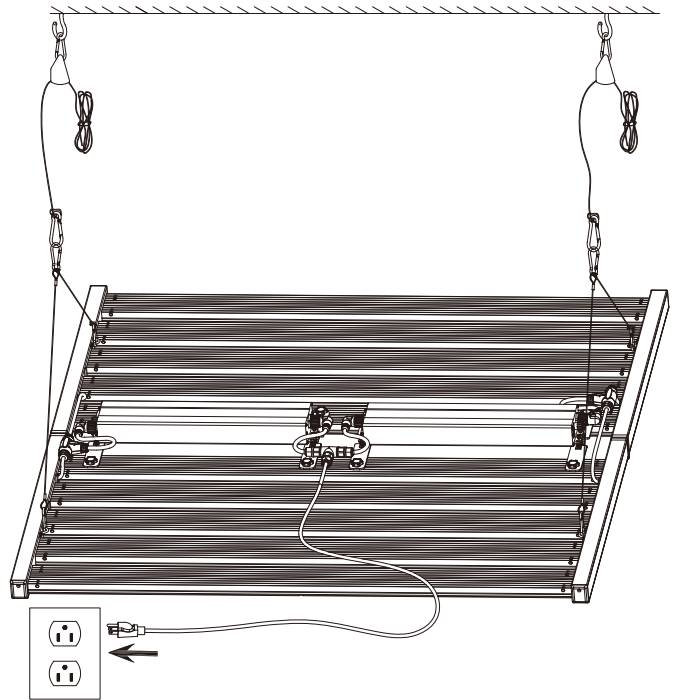

Connect the AC power plug into the mains (wall outlet).

